

# General Information Table of Contents

<b>Standard</b>	<b>Title</b>
GI 001	General Specifications for Underground Structures
GI 001.1	General Specifications
GI 010	Specifications for Joint Construction
GI 010.1	Specifications for Joint Construction
GI 020	General Specifications for Concrete and Reinforced Concrete
GI 020.1	General Specifications for Concrete and Reinforced Concrete
GI 025	Steel Shape Dimensions
GI 025.1	Steel Shape Dimensions
GI 030	Specification for Precast Reinforced Concrete Structures
GI 030.1	Specification for the Structural Design and Manufacturing of Precast Reinforced Concrete Structures
GI 030.2	Setting Cover Depths for Tunnel/Tub Style Vaults and Manholes
GI 031	Acceptance Criteria for the Installation of New Precast Vaults and Manholes
GI 031.1	Acceptance Criteria for the Installation of New Precast Vaults and Manholes
GI 035	Maximum Allowable Tolerances for Installed Precast Vaults and Manholes (Inside Joint Surfaces)
GI 035.1	Maximum Allowable Tolerances for Installed Precast Vaults and Manholes (Inside Joint Surfaces)
GI 040	General Specifications for Pull Rope and Pull Tape
GI 040.1	General Specifications for Pull Rope and Pull Tape
GI 045	General Specifications for Plowing Cable
GI 045.1	General Specifications for Plowing Cable
GI 050	Specification for Abandoning Substructures
GI 050.1	Specification for Abandoning Substructures

Approved by: 	<b>General Information Table of Contents</b>	<b>GI</b>
Effective Date: 10-23-2015		Sheet i
		<b>UGS</b>

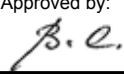

**GI 001      General Specifications for Underground Structures**

**Scope GI 001.1      General Specifications**

**1.0      General Agreement**

The Master Agreement entered into between the contractor and the Company will form the basis for all work performed, and the specifications, requirements, and conditions described herein are in addition thereto and will also be a part of the basis for all work performed and will apply in the manner set forth herein unless otherwise modified or described in the working drawings or in the agreement for a specific installation.

**2.0      Working Drawings**

**2.1      Quantity and Type of Structures and Facilities**

Each working drawing will indicate the structures and facilities to be installed both by type and quantity. Charges to the Company for work performed will be subject to adjustment, as agreed upon in each instance between the contractor and an authorized representative of the Company whenever modification is made in either the type or quantity of such structures or facilities.

**2.2      Location of Structures and Facilities**

Each working drawing will also indicate the preferred location of structures and facilities to be installed. Deviations in such preferred locations may be made as agreed upon between the contractor and an authorized representative of the Company. Adjustments in charges to the company based upon such deviations will be limited to those for changes in type and quantity of structures and facilities as set forth in above, provided, however, that this restriction will not apply to deviations made solely for the convenience of the Company.

**2.3      Obstructions in the Vicinity**

Each working drawing will also indicate, to the extent known by the Company, the approximate plan of obstructions in the vicinity. It will be the contractor's responsibility solely and entirely to determine the actual location of all obstructions, whether known to the Company or not by means of test holes and otherwise as may be necessary or advisable.

**3.0      Structures and Accessories**

**3.1      Structure Requirements and Drawings**

Each structure or facility installed will be in accordance with, and will include accessories or meet other requirements as set forth in, the reference page listed below. The current revision, as of date of working drawing, of each structure drawing, accessory drawing, or other reference drawing, is the only one applicable; use of a previously-issued drawing is contingent upon such drawing still being the current revision.

**3.2      Vaults**

Each vault will be in conformance with requirements given in [VA 400](#).

Approved by: 	<b>General Specifications for Underground Structures</b>	<div style="font-size: 2em; font-weight: bold; margin: 0;">GI 001</div>
Effective Date: 10-31-2008	<b>What's Changed?</b>	Sheet 1 of 3 <div style="font-size: 2em; font-weight: bold; margin: 0;">UGS</div>

**3.3 Manholes**

Each manhole will be in conformance with requirements given in [MH 300](#).

**3.4 Pull Boxes**

Each pull box will be in conformance with requirements given in [HP 210](#).

**3.5 Handholes**

Each handhole will be in conformance with requirements given in [HP 200](#).

**3.6 Slab Boxes**

Each slab box will be in conformance with requirements given in [SS 530](#).

**3.7 Conduit Banks**

Each conduit bank and terminal will be in conformance with requirements given in [CD 100](#).

**3.8 Subsurface Structure**

Each subsurface structure will be in conformance with requirements given in [SS 560](#).

**4.0 Material Furnished by the Contractor**

The following materials are furnished by the contractor (without cost to the Company) for installation in accordance with Company specifications.

- Ground rods, clamps, and wire
- Ground connectors for HDG grounding

**5.0 Material Furnished by the Company**

The Company will only furnish copper wire for buried neutral in trenches. This material is furnished by the Company without cost to the contractor for installation in accordance with Company specifications, and will be made available at the individual Service Centers.

**6.0 Referenced Specifications**

The following specifications when referenced in this specification are part of this specification. Unless otherwise stated, references are to the latest revision. This specification will stand in case of conflicts unless otherwise noted in a specific section.

- Standard Specification for Public Works Construction—referenced as “Greenbook” in this specification
- American Society for Testing Materials (ASTM)

**7.0 Cover Bolts**

Apply silicone grease to cover bolts before installation to minimize removal difficulties.

**8.0 Warning Signs and Company Identification**

Warning signs indicating high voltage shall be installed on an interior surface, or barrier if present, inside the entrance of vaults, manholes, handholes, pad-mounted transformer compartments, and other above-ground enclosures containing exposed live parts above 750 V. Such warning signs shall also be

<b>GI 001</b>	<b>General Specifications for Underground Structures</b>	Approved by: 
Sheet 2 of 3	<b>What's Changed?</b>	Effective Date: 10-31-2008
<b>UGS</b>		

installed on an exterior surface of all such pad-mounted transformer compartments and other above-ground enclosures. Such signs shall be clearly visible to a person in position to open any such access door, other opening, or barrier.

**9.0 Excavation**

Prior to excavating, the California One Call Law requires any person planning to conduct any excavation shall contact Underground Service Alert, at least two working days (48 hours), but not more than 14 calendar days, prior to commencing that excavation. Dial 811 for Underground Service Alert.

Approved by: 	<b>General Specifications for Underground Structures</b>	<b>GI 001</b>
Effective Date: 10-31-2008	<b>What's Changed?</b> Section 9.0 (Excavation) was added to inform the user to call (811) 48 hours prior to excavating.	Sheet 3 of 3 <b>UGS</b>

This page intentionally left blank.

**GI 010 Specifications for Joint Construction**

**Scope GI 010.1 Specifications for Joint Construction**

**1.0 General**

The specifications of each party will be complied with, for their respective portions of construction jointly entered into, except as otherwise detailed on working drawings or as provided for in the agreement for the work being done.

**2.0 Working Drawings**

Working drawings will indicate the structures and facilities to be installed both by type and quantity. Modifications will be made only as authorized by the respective party or parties concerned.

**3.0 Divisions of Cost**

Costs will be proportioned as agreed upon in each instance, except as otherwise provided for; changes, adjustments, and similar matters will be in accordance with established practice between the contractor and each respective party.

**4.0 Service Laterals**

The contractor will mark location of all service laterals at time of installation.

Approved by: 	<b>Specifications for Joint Construction</b>	<div style="font-size: 2em; font-weight: bold; margin: 0;">GI 010</div>
Effective Date: 01-26-2007	<b>What's Changed?</b>	Sheet 1 of 1 <div style="font-size: 2em; font-weight: bold; margin: 0;">UGS</div>

This page intentionally left blank.



**GI 020 General Specifications for Concrete and Reinforced Concrete**

**Scope GI 020.1 General Specifications for Concrete and Reinforced Concrete**

**1.0 Materials**

**1.1 Portland Cement**

Cement used will be Portland Cement in accordance with ASTM Designation: C 150, as last adopted or revised. Type II low alkali, or Type V, low alkali Portland cement will be used unless otherwise specified by the Company.

**1.2 Concrete Aggregates**

- A. Aggregates will conform to ASTM Designation: C 33 (as last adopted or revised) with respect to general characteristics, soundness, and freedom from deleterious material. Aggregate source will have a petrographic analysis less than one year old on file at the batch plant. Petrographic analysis will be per ASTM C295. If indicated, further tests per ASTM C289 or C586 should be performed.
- B. Fine aggregates will be well graded and washed natural sand without shale, alkali, mica, coated grains, or soft or flaky particles. The fine aggregate will conform to requirements of Section 200-1.5 of the Greenbook for Portland Cement concrete.
- C. Coarse aggregates will be clean, sound gravel, well graded in sizes. Coarse aggregate will conform to Section 200-1.4 of the Greenbook for the maximum size of the mix.

**1.3 Water**

Water used in mixing concrete will be clean, clear, potable, and free of materials likely to be harmful to the concrete.

**1.4 Metal Reinforcement**

- A. Reinforcing bars will be a deformed type and will conform to ASTM A615 Grade 40 or Grade 60 billet steel. Steel will be accurately bent, placed, tied, and supported in accordance with the requirements of Manual of Standard Practice of the Concrete Reinforcing Steel Institute (CRSI).
- B. Welded wire fabric will conform to ASTM A185 or A497.

**1.5 Admixtures**

Calcium chloride will not be used. Liquid admixtures meeting the requirements of ASTM C494, Type B, D, F, or G may be used in the mix in accordance with the manufacturers recommendations. Class F flyash meeting the requirements of ASTM C618 may be used in amounts of between 20% and 25% of total cementitious weight.

All concrete mixes for the utility boxes shall contain 4.0 gallons of calcium nitrite corrosion inhibitor per cubic yard of concrete, conforming to ASTM C494, Type C or Type S, Calcium Nitrite based with a solids content of 30%. The corrosion inhibitor shall be added in accordance with the manufacturer's instructions and/or recommendations.

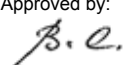
Approved by: 	<b>General Specifications for Concrete and Reinforced Concrete</b>	<b>GI 020</b>
Effective Date: 01-31-2014	<b>What's Changed?</b> The range for flyash was updated from 10 to 15% to 20 to 25%. A new paragraph regarding calcium nitrite was added.	Sheet 1 of 8 <b>UGS</b>

**1.6 Ready Mixed Concrete**

Ready mixed concrete will conform to ASTM Designation: C94-44 as last adopted or revised. There will be furnished with each load, a legible certificate describing the mix, identifying the materials used, and stating the quantity of additional water, if any, which may be added to the mix to bring it to the specified water-cement ratio. Edison inspector is to check mix receipt prior to pour of all poured-in-place structures.

**2.0 Concrete Designs**

**2.1 Measurements**

- A. Measurements are to be determined at a temperature of 70° F. When the ambient differs, the values will be corrected to 70° F.
- B. Water content is the gross amount of water in the mix, including surface water contained on the aggregate.
- C. See Section 2.4 (Sheet 4) for Slump Measurements.
- D. Deviations in specifications require variations in the design and are limited to those detailed in Section 2.3 (Sheet 3), Variations Required for Deviations.

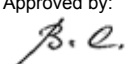
GI 020	General Specifications for Concrete and Reinforced Concrete	Approved by: 
Sheet 2 of 8	What's Changed?	Effective Date: 01-31-2014
UGS		

## 2.2 Mix Designs

**Table GI 020–1: Concrete and Reinforced Concrete Mix Designs**

Mix Designation	SCE UG 4000	SCE UG 4001	SCE UG 4002
Water/Cement Ratio	0.45 ± .05	0.45 ± .05	0.45 ± .05
Minimum Cement Content			
Sacks per Cubic Yard	5.5	6.3	6.0
Maximum Size Coarse Aggregate	1-1/2"	1-1/2"	3/4"
Aggregate Gradation Class <sup>a/</sup>	B	C	–
% Passing Sieve Size			
2"	100		
1-1/2"	95–100	100	
1"	80–96	95–100	100
3/8"	64–80	77–93	95–100
3/8"	40–52	50–70	70–88
No. 4	35–45	39–51	40–53
No. 8	28–38	31–41	31–43
No. 16	21–31	22–32	22–34
No. 30	10–20	12–22	14–24
No. 50	3–9	3–9	4–10
No. 100	0–3	0–3	0–3
No. 200	0–2	0–2	0–2
Allowable Slump-Inches <sup>b/</sup>			
Maximum	3	5	3
Minimum	2	3	2
Strength Requirements (psi at 28 days)	3,000	3,000	3,000
Compaction Method	Vibrator	Hand	Vibrator

<sup>a/</sup> Per Greenbook 201-1.3.2

<sup>b/</sup> Slump measured before addition of water reducing admixtures

## 2.3 Variations Required for Deviations

### A. Angular Coarse Aggregate

- Angular coarse aggregate may be used in a mixture designed for vibrator compaction provided.
  - Fine aggregate percentage of total aggregate, by absolute volume, is increased 5%.
  - Cement content is increased 0.7 sack per cubic yard and the water-cement ratio is kept within the specified.
- Angular coarse aggregate may be used in mixtures designed for hand compaction without increase in cement content provided that the fine aggregate percentage of total aggregate, by absolute volume, is increased 5%.

Approved by:

*B. C.*

General Specifications for Concrete and Reinforced Concrete

**GI 020**

Sheet 3 of 8

Effective Date:

01-31-2014

What's Changed?

**UGS**

**B. Grading of Aggregates**

1. No variation allowed in grading of fine aggregates without special authorization.
2. The “well graded” characteristics of both fine and coarse aggregates will be such as to yield a smooth, plastic, cohesive mass of wet concrete when the water content and slump are within specified limits. Cement content will be increased as necessary to obtain this result whenever the aggregate grading used does not produce such results.

**C. Slump**

Slump may be increased to a maximum of four inches provided that the cement content is increased at the rate of 1/3 sack of cement per cubic yard of concrete for each inch or fraction beyond the maximum slump specified and provided the required water-cement ratio is maintained. Higher slump values will be achieved by use of water reducing admixtures when required to ease placement and consolidation.

**D. Water-Cement Ratio**

No deviations except slabs on grade may have a water-cement ratio of 0.50 and minimum cement content of five sacks per cubic yard.

**E. Hand-Compaction**

Concrete will not be hand-compacted unless directed by SCE. Concrete requiring hand-compaction will utilize water reducing admixtures.

**2.4 Slump Measurements**

- A. Slump is to be determined in accordance with ASTM Designation: C143-39 or the latest revision thereof.
- B. Slump is to be determined at 70° F. When measurements are made at any other temperature the slump value used will be that measured after correcting as follows:
  1. At high temperatures, add to the measurement obtained at the rate of 3/8 inch for each 10° F, but not more than 3/4 inch total correction.
  2. At lower temperatures, subtract from the measurement obtained at the rate of 1/2 inch for each 10° F below 70° F. See Section 2.12 (Sheet 7) regarding extreme temperatures.
- C. Edison inspector may take slump tests prior to pour.
- D. Slump measurements are prior to addition of water reducing admixtures.

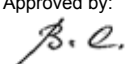
<b>GI 020</b>	<b>General Specifications for Concrete and Reinforced Concrete</b>	Approved by: 
Sheet 4 of 8	<b>What's Changed?</b>	Effective Date: 01-31-2014
<b>UGS</b>		

**2.5 Application of Designs**

- A. For structures with wall thickness of five inches or more:
  - SCE UG #4000—Floors, decks, and slabs
  - SCE UG #4001—Floors, decks, and walls
- B. For structures with wall thickness less than five inches:
  - SCE UG #4002
- C. For conduit envelopes:
  - see [CD 100](#).

**2.6 Forms and Supports**

- A. Forms will be smooth and in accordance with Greenbook Section 303–1.3, surface (if wood forms) treated with oil, well braced, and must be tight enough to prevent any leakage of mortar. They will hold the concrete in such manner that the finished structure conforms to the shape and dimensions specified. Tape or other impervious membrane covering will be used as necessary to obtain tight form joints.
- B. Earth surfaces, where used as forms, will be covered with a tough impervious membrane such as sisal kraft or a similar material. No such covering is required under floors except where the earth is porous and very dry or where ground water is present. Pours against earth surfaces will be allowed provided earth is dampened well prior to pour to avoid earth from removing moisture in concrete mix.
- C. Supports resting on the earth, and to become a part of the finished structure, will be precast concrete equal to that in the structure.
- D. Supports bearing on forms, and to become a part of the finished structure, will be iron or steel in appropriate shapes.
- E. Duct separators will be precast concrete or a suitable inorganic material, either ceramic or pressed, to serve the purpose.

**2.7 Placing Reinforcement**

- A. Metal surfaces will be clean and free of rust, scale, or other coatings such as might reduce bonding of the concrete.
- B. Reinforcement will be securely tied and in place before any concrete is poured in the structure except under the following conditions:
  - 1. Where cold joints are specified or allowable.

Approved by:	<b>General Specifications for Concrete and Reinforced Concrete</b>	<b>GI 020</b>
Effective Date:	<b>What's Changed?</b>	Sheet 5 of 8
01-31-2014		<b>UGS</b>

2. Roof sections having been assembled and placed may be removed as an entire section, temporarily, if this is feasible.

C. Tolerances for steel clearance and spacing:

1. Clearances of three inches or less will not be reduced but may be increased by one-half inch. Other clearances may vary one-half inch either way.
2. Location of reinforcing elements may vary up to two inches from that specified provided clearances are maintained and provided clear separation between adjacent parallel pieces, of less than two inches, is not reduced.

D. Steel spacing pieces, chairs or similar supporting devices, will be used as necessary to assure conformance of steel locations specified within the allowed tolerance.

2.8 Preparation of Cold Joints

- A. The concrete surface to be joined will be clean and free of loose material.
- B. Sika seal or other specified material will be applied to form a sealing membrane.

2.9 Placing Concrete

- A. Concrete will be handled from mixer to place of final deposit as rapidly as practicable by methods which will prevent segregation or loss of ingredients. It will be placed in such manner as to avoid any appreciable flowing after the final depositing.
- B. The placement will be continuous and at such rate that cold joints do not develop excepting where cold joints are specified or optional. Where cold joints occur, an approved bonding agent will be used.
- C. Steel and forms will be kept clean and free of concrete until covered with the pour.
- D. Platforms, drop chutes, sheeting and similar devices must be used as necessary to prevent segregation.
- E. Unless deposited by tremie or pipe (6 inches minimum diameter) concrete for vault and manhole walls will first be deposited at roof level, then shoveled and dropped carefully straight down in such manner that segregation does not occur.

2.10 Compaction

- A. Vibration compaction will be used with each design so specifying. Such compaction will be done with an approved, internal type, mechanical vibrator having a speed not less than 4,500 Revolutions-Per-Minute (RPM), operated and moved continuously by an experienced operator and augmented by rod tamping as necessary. Successive layers not more than 24 inches deep

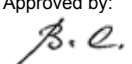
<b>GI 020</b>	<b>General Specifications for Concrete and Reinforced Concrete</b>	Approved by: 
Sheet 6 of 8	What's Changed?	Effective Date: 01-31-2014
<b>UGS</b>		

will be placed and well compacted before placing each following layer. The vibrator will be inserted at about 18-inch intervals, will penetrate each layer completely and will penetrate a preceding layer at least 12 inches.

- B. Hand compaction will be used with each design so specifying. Such compaction will be done with tamping rods being worked continuously through the wet mass as placed. Successive layers of not more than 12 inches will be placed and well compacted before placing each following layer. Tamping rods will be used at the rate of one for each two yards per hour maximum rate of pouring. At least one man-hour of tamping will be performed in each two yards of concrete poured in vaults and manholes. At least one man-hour of tamping will be performed in each four yards poured for conduit bank envelopes or pull boxes.
- C. Compaction in the specified manner and at the required rate will be performed in all concrete poured. This includes floors and roofs of structures as well as walls and includes pads and conduit bank envelopes.

**2.11 Surface Finishes**

- A. Rock pockets and other imperfections on exposed surfaces will be patched and troweled to match the surrounding surface.
- B. Floors will be given a float or broom finish to provide a uniform but slightly rough surface.
- C. When a finish course is poured on concrete which has set, it will be at least two inches thick and in addition to the specified floor thickness.

**2.12 Protection while Pouring and Curing**

- A. Concrete will be placed with the temperature of the mix between 40° F and 90° F.
- B. When the ambient air temperature is below 40° F the concrete will be held to a temperature between 60° F and 90° F until set. Concrete will not be placed during freezing temperatures without special authorization.
- C. Protection will be provided as necessary to guard against freezing, premature drying, and any other conditions likely to be injurious to the concrete, until the specified strength is developed.
- D. Concrete will be cured in accordance with Greenbook Section 303-1.10. Curing will be continued for at least seven days except that this time may be reduced as authorized by the Company when "high early strength" cement is specified.

**2.13 Removal of Forms**

- A. Supporting forms will be left in place until the concrete has developed sufficient strength to be self-supporting without damage to itself. Outside shoring may be removed after 24 hours.

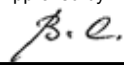
Approved by: 	<b>General Specifications for Concrete and Reinforced Concrete</b>	<b>GI 020</b>
Effective Date: 01-31-2014	<b>What's Changed?</b>	Sheet 7 of 8 <b>UGS</b>

B. The following are the minimum periods during which forms will be left in place when Type II cement is used and curing conditions are favorable:

1. 100 hours for roof supports
2. 100 hours for wall supports where the soil is not self-supporting
3. 75 hours for wall supports where the soil is self-supporting

**2.14 Purpose of Specification**

The foregoing specifications are designed to produce a durable concrete with more than the specified minimum strength. The values and procedures specified are guides to be followed to obtain the required results and do not preclude in any manner such additional measures as may be necessary or advisable to secure such results, regardless of the results of any tests which may be made.

**2.15 Rejected Installations**

An installation may be rejected when:

- A. Samples taken while pouring, or core samples taken within three months thereafter, fail to meet the required strength.
- B. The specified concrete thickness has not been met in the structure.
- C. It is found that concrete has not been properly consolidated resulting in a porous structure.
- D. The water-to-cement ratio of the concrete is in excess of that specified regardless of strength or other tests made.
- E. Concrete has been poured with insufficient concrete cover over the reinforcing steel.
- F. Other requirements of this specification or other referenced specifications have not been met resulting in a structure which cannot take specified loads, may deteriorate, or which (for water-resistant structures) cannot keep water out.

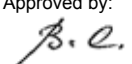
<b>GI 020</b> Sheet 8 of 8 <b>UGS</b>	<b>General Specifications for Concrete and Reinforced Concrete</b>	Approved by: 
	<b>What's Changed?</b>	Effective Date: 01-31-2014



**GI 025 Steel Shape Dimensions**

**Scope GI 025.1 Steel Shape Dimensions**

In general, inside and inside-to-inside dimensions will be shown. Multiple dimensions to a bend of less than 90 degrees in a piece will all be based upon one designated point on the inner surface of such bend. The diagrams illustrate the manner in which most common details will be dimensioned. These practices are applicable where this sheet is used as reference unless details are shown in some other manner.

**1.0 Right Angle Bends**

Show dimension to point of tangency extended as indicated by Dimension #1, [Figure GI 025–1 \(Sheet 1\)](#).

**Figure GI 025–1: Steel Shape Dimensions — Right Angle Bends**

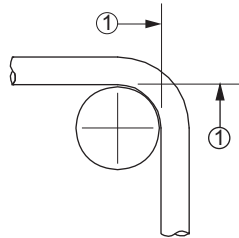

**2.0 Bends Less than 90°**

Show dimension to point of tangency as indicated by Dimension #2, [Figure GI 025–2 \(Sheet 1\)](#).

**Figure GI 025–2: Steel Shape Dimensions — Right Angle Bends**

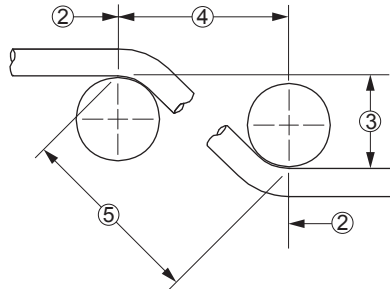

**3.0 Offsets with Parallel Members**

3.1 Show offset between points of tangency extended as indicated by Dimension #3, [Figure GI 025–2 \(Sheet 1\)](#).

3.2 Show run between perpendiculars to points of tangency as indicated by Dimension #4, [Figure GI 025–2 \(Sheet 1\)](#).

3.3 Omit Dimension #5.

Approved by: 	<b>Steel Shape Dimensions</b>	<b>GI 025</b>
Effective Date: 01-26-2007	<b>What's Changed?</b>	Sheet 1 of 2 <b>UGS</b>

**4.0 Offsets with Non-parallel Members**

- 4.1 Show run as distance between perpendiculars, to direction of dimension, which pass through the points of tangency. This dimension will be similar to #4 in Figure GI 025–2 (Sheet 1) except one perpendicular will not pass through the center of a shaping pin.
- 4.2 Show diagonal dimension as indicated by Dimension #5, Figure GI 025–2 (Sheet 1).
- 4.3 Omit Dimension #3.

**5.0 Bends More than 90°**

Show dimension to perpendicular tangent to far face of shaping pin as indicated by Dimension #6, Figure GI 025–3 (Sheet 2).

**Figure GI 025–3: Steel Shape Dimensions — Bends Less Than 90°**

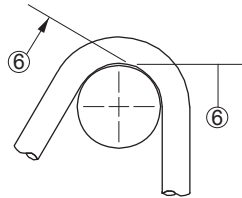

<b>GI 025</b>	<b>Steel Shape Dimensions</b>	Approved by: 
Sheet 2 of 2	<b>What's Changed?</b>	Effective Date:
<b>UGS</b>		01-26-2007

**GI 030 Specification for Precast Reinforced Concrete Structures**

**Scope GI 030.1 Specification for the Structural Design and Manufacturing of Precast Reinforced Concrete Structures**

**1.0 General**

- 1.1 This specification outlines the minimum requirements for precast reinforced concrete vaults, manholes, slab boxes, pullboxes, and other wet cast precast structures. The structures will also conform to all applicable UGS standards and the requirements for the appropriate regulatory agencies.
- 1.2 A copy of design calculations and drawings approved by a civil engineer registered in California will be submitted for review and approval.
- 1.3 Exceptions to this specification will be made only with written authorization from SCE.
- 1.4 Vaults and manholes will be designed and constructed to be water tight.
- 1.5 Structure sizes, openings, recesses, and other accessories will conform to VA 400 (for vaults) and MH 300 (for manholes), HP 210 (for pullboxes) and SS 500 (for slab boxes and other subsurface structures).
- 1.6 All submittals for review and approval will be made to the Customer Service Engineering section of the Southern California Edison Company.
- 1.7 The structures will be warranted for one year against design and manufacturing defects including those resulting from poor workmanship and materials.
- 1.8 The structure design of precaster's vaults and manholes will be approved by Los Angeles County Department of Public Works, Design Division, Bridge Section.
- 1.9 All metal lifting devices cast into the internal or external surfaces of vaults or manholes by the precaster for handling or setting purposes will be hot-dipped galvanized or made from stainless steel.

**2.0 Structural Design**

- 2.1 Structural design will conform to the latest edition of the Standard Specifications for Highway Bridges as adopted by the American Association of State Highway and Transportation Officials (AASHTO) and ASTM C 857, the Standard Practice for Minimum Structural Design Loading for Underground Precast Concrete Utility Structures.
- 2.2 The following loading assumptions are for vaults and manholes in general use on the SCE system. Designs for specific loading conditions may be submitted on an individual basis.
  - A. The design vehicle loads will be HS-20; traffic can approach the structure from any direction.
  - B. A 30% increase of design live load will be used for impact loading.
  - C. There will be a minimum of 24 inches of cover measured from the flow line of the gutter. See notes in [Scope GI 030.2 \(Sheet 6\)](#).

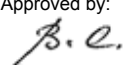
Approved by: 	<b>Specification for Precast Reinforced Concrete Structures</b>	<b>GI 030</b>
Effective Date: 01-31-2014	<b>What's Changed?</b>	Sheet 1 of 6 <b>UGS</b>

D. Structures will be designed for vertical and lateral soil pressure based on the conditions found in the field and considering the rigidity of the structure. However, the minimum lateral soil pressures that may be used are 35 pounds per cubic foot (pcf) equivalent fluid pressure above the water table and 80 pcf equivalent fluid pressure below the water table.

E. The groundwater table will be assumed to be three feet below the finished surface.

2.3 The load factor method of design will be used.

2.4 Fatigue stress limits will be applied to traffic loads in accordance with section 1.5.38 of the ASSHTO specifications.

2.5 All vault and manhole walls, floors, and ceilings will have a minimum thickness of five inches.

**3.0 Reinforced Concrete**

3.1 Criteria for Normal Weight Concrete

A. Aggregates will meet the requirements of ASTM C 33. A certificate of compliance will be submitted by the aggregate producer. A petrographic analysis of aggregate will be submitted at least yearly, and with each change of aggregate source.

B. Concrete mix designs will be approved by a civil engineer registered in California, and will be submitted to SCE for review and approval.

C. ASTM C 150, Type II low alkali, or Type V low alkali cement will be used.

D. Class F flyash meeting the requirements of ASTM C 618 will be used. The recommended amount of flyash will not be less than 20% or more than 25% of the total cementitious weight (cement and flyash).

E. The minimum compressive strength of concrete will not be less than 4,500 pounds per square inch (psi) in 28 days as determined by the American Society for Testing Materials (ASTM) method C 39-72 Standard Method of Test for Compressive Strength of Cylindrical Concrete Specimens. Test specimens will be cured as per ASTM C 31. Slabs on grade may have 3000 psi concrete at 28 days.

F. The maximum water-cement or water-cementitious ratio will be 0.45.

G. Liquid admixtures meeting the requirement of ASTM C 494, type B, D, F, or G may be used in the mix in accordance with manufacturer's recommendations. No other admixtures will be used unless otherwise approved by SCE.

All concrete mixes for the utility boxes shall contain 4.0 gallons of calcium nitrite corrosion inhibitor per cubic yard of concrete, conforming to ASTM C494, Type C or Type S, Calcium Nitrite based with a solids content of 30%. The corrosion inhibitor shall be added in accordance with the manufacturer's instructions and/or recommendations.

<p><b>GI 030</b></p>	<p><b>Specification for Precast Reinforced Concrete Structures</b></p>	<p>Approved by: <i>B. C.</i></p>
<p>Sheet 2 of 6</p>	<p><b>What's Changed?</b> The range for flyash was updated from 10 to 15% to 20 to 25%. A new paragraph regarding calcium nitrite was added.</p>	<p>Effective Date:</p>
<p><b>UGS</b></p>		<p>01-31-2014</p>

- H. No additives containing calcium chloride or any other material that will produce corrosive ions will be used in the concrete. All additives will be submitted to SCE for approval prior to use.
- I. The concrete finish will be free of rock pockets and honeycombed areas. The interior walls and ceilings and exterior surfaces exposed to view will be smooth. The exterior surface below grade will be dense and uniform, but a slight roughness is not objectionable. Floors will have a form finish. Air holes over 3/8 inch deep will be patched.
- J. The concrete will be cured per the AASHTO specifications. Other methods may be acceptable if approved by SCE in writing.

**3.2 Lightweight Concrete**

Lightweight concrete is not approved for use in the manufacturing of any SCE structure.

**3.3 Concrete Protection for Reinforcement**

- A. The concrete protection (cover) for reinforcement will be 1-1/2 inches minimum for main reinforcing bars and 1 inch minimum for stirrups and ties, except at joints where there can be 1 inch minimum cover for main bars from concrete surfaces that will be treated with a waterproofing material.
- B. The cover to diameter of bar ratio will be a minimum of 2.0.
- C. The concrete cover will be measured from the surface of the concrete to the outside surface of the bar.

**3.4 Reinforcing Steel**

- A. Reinforcing steel will conform to the AASHTO specifications.
- B. Reinforcing steel will be accurately bent and placed and firmly tied.
- C. Reinforcing steel will be adequately supported in place by use of plastic or stainless steel chairs, or concrete blocks manufactured from concrete conforming to Section 3.1 (Sheet 2) of this specification. If concrete blocks are used, the tie wires will have a minimum cover of 3/4 inch.
- D. Welding of reinforcing steel will conform to the Structural Welding Code, Reinforcing Steel (AWS D1.4-79) of the American Welding Society.

**4.0 Identification**

All structures will be identified with manufacturer's name, date of manufacture, and nominal size or identifying number permanently attached to an interior surface of each precast concrete section.

**5.0 Quality Control and In-Plant Inspection**

- 5.1 The supplier will have a quality control program including testing and inspection to ensure the quality of the product.

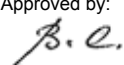
Approved by: 	<b>Specification for Precast Reinforced Concrete Structures</b>	<b>GI 030</b>
Effective Date: 01-31-2014	<b>What's Changed?</b>	Sheet 3 of 6 <b>UGS</b>

- 5.2 Precasters will submit a quality control plan for the Company's approval. Any proposed changes to the precaster's existing quality control plan will be submitted to Edison for review and approval before implementation. This plan will include 1) controlling concrete components (cement, aggregate, and water), 2) testing of concrete, 3) controlling concrete mixing, 4) controlling concrete placement and form stripping, 5) inspecting rebar, 6) controlling bending and placing of rebar, 7) inspection of the finished product, and 8) documenting and filing of test and inspection results.
- 5.3 In-Plant inspection by SCE
  - A. Vaults and manholes will be identified through all phases of construction as one that is to be used by Edison.
  - B. Edison inspectors will have access and assistance in inspecting the work. Inspectors will not be required to give prior notice of inspections.
- 5.4 The acceptance criteria for precast concrete vaults and manholes is given in [GI 031](#).
- 5.5 Variations and dimensional tolerances will be those specified in the latest ASTM C858, the Standard Specification for Underground Precast concrete Utility Structures, except that concrete cover over reinforcing steel will not be less than specified in Section 3.4 ([Sheet 3](#)) of this specification.

**6.0 Installation**

- 6.1 No precast structure will be shipped to the jobsite before the concrete has attained its full design strength.
- 6.2 The SCE inspector will be notified by the installing contractor 48 hours prior to the field installation of vaults and manholes.
- 6.3 Excavation and Rock Base
  - A. All excavations will be in accordance with safe construction practices.
  - B. Excavations for vaults and manholes will be of a depth to provide the minimum/maximum setting cover depths over the outside top of the structure roof as specified in notes in [Scope GI 030.2 \(Sheet 6\)](#).
  - C. A 6-inch minimum thickness of crushed aggregate, 3/8" x 3/4" crusher run rock, mechanically compacted will be placed below the vaults and manholes and extend to the sides of the excavation. Pullboxes will have 6 inches of compacted rock, 3/8" x 3/4", as a base to assure uniform pressure distribution.
  - D. The bottom of the excavation will be free of standing water.
  - E. There will be a minimum of 6 inches clearance from the outside perimeter of the structure walls to all side surfaces of the excavation.

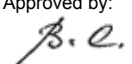
<b>GI 030</b>	<b>Specification for Precast Reinforced Concrete Structures</b>	Approved by: 
Sheet 4 of 6	<b>What's Changed?</b>	Effective Date: 01-31-2014
<b>UGS</b>		

6.4 Backfill around and over the structure will be with a minimum of one sack per yard sand cement slurry, 1-1/2 sacks per yard for Cal Trans jobs. The surface elevation of the backfill slurry will not vary more than one foot around the perimeter of the structure as it is being placed.

6.5 Instructions

- A. If the manufacturer does not erect the structure, he will forward installation instructions and recommendations to the installing contractor.
- B. The contractor will install the structures in accordance with the manufacturer's instructions and recommendations.

6.6 Joints

- A. All joints will be waterproofed using methods and sealing materials that have been specified by SCE. Changes to approved methods and materials will be submitted to SCE 90 days prior to use.
- B. Prime paint all joint surfaces of tunnel vaults prior to delivery to insure that approved joint sealing material will be retained in joint during structure installation.
- C. For tunnel type structures use mechanical or air wrenches per precast concrete supplier instruction, retightening after backfill.
- D. Joint sealing materials will be placed on each flat surface of the joint. Approved joint sealing material will be a minimum of 1-1/4-inch diameter. Approved joint sealants, General Sealant #5, RUB'R-NEK T-L-M, or equivalent.
- E. Vault/Manhole necking joints will have a 1/4 inch coat of bonding adhesive applied on the outside surface of the joint, after being adjusted to grade and before backfilling. The bond adhesive will extend two inches above and below each joint. (May be applied inside the structure when adjusting grade on existing vaults and manholes.)

UBA-18	2-88-1
ASTC Polymers	Saf-T-Co Supply
3207 W. Warner Avenue	1300 E. Normandy Place
Santa Ana, CA 92704	Santa Ana, CA 92705
(714) 966-2893	(714) 547-9975

6.7 Separation and Reinstallation of Structures

- A. Caution must be taken when it becomes necessary to remove a precast vault or manhole section after it has been set in place with joint sealants.
- B. When attempting to separate and/or lift structure sections, the individual section weight can greatly increase due to the adhesion of the joint sealant to the adjacent section. This increased weight can exceed the design limits of the precaster's cast-in-place lifting devices.
- C. Contact the precast manufacturers for recommended methods of separating the individual sections.

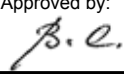
Approved by: 	<b>Specification for Precast Reinforced Concrete Structures</b>	<b>GI 030</b>
Effective Date: 01-31-2014	<b>What's Changed?</b>	Sheet 5 of 6
		<b>UGS</b>

**Scope GI 030.2 Setting Cover Depths for Tunnel/Tub Style Vaults and Manholes**

**Note(s):**

1. Minimum setting cover depths for tunnel and tub style vaults and manholes installed in roadway or sidewalk/parkway locations is 24 inches. This dimension is taken from the gutter flow line to the outside top of the structure roof. Vaults or manholes placed in private property will have a minimum setting depth of 24 inches from grade to the outside top of the structure roof.
2. Maximum place cover depth is 48 inches, measured from grade to top outside surface of structure roof. If structure cover depths over 48 inches are required, contact the Division Underground Planning Supervisor.
3. The listed structure minimum/maximum setting cover depths are to Edison's requirements. Local governmental agencies may require greater cover depths than stated.

**Figure GI 030-1: Setting Cover Depths for Tunnel/Tub Style Vaults and Manholes**

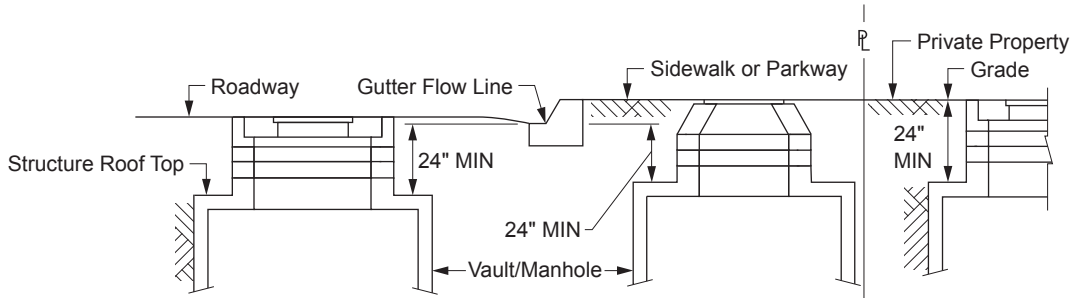

<b>GI 030</b>	Specification for Precast Reinforced Concrete Structures	Approved by: <i>B. C.</i>
	Sheet 6 of 6	Effective Date: 01-31-2014
<b>UGS</b>	What's Changed?	



**GI 031 Acceptance Criteria for the Installation of New Precast Vaults and Manholes**

**Scope GI 031.1 Acceptance Criteria for the Installation of New Precast Vaults and Manholes**

**1.0 Purpose**

To set criteria for acceptability and repair of new precast concrete vaults and manholes from manufacture through the warranty period.

**2.0 General**

- 2.1 All repairs referred to in this criteria will be performed by the manufacturer in his yard and the supplier<sup>1/</sup> in the field.
- 2.2 Repairs will be performed in accordance with SCE's MC 860.
- 2.3 These procedures assume an adequate design is used per good, standard engineering practices, with sound materials and good workmanship conforming to the design. This criteria will not limit SCE's recourses if the above assumptions are not met.
- 2.4 Supplier will provide a one (1) year warranty on all repairs and patches.
- 2.5 The supplier will not be held responsible for damage that can be determined to be caused by unusual conditions outside of his control.

**3.0 Actions While in Manufacturer's Yard**

- 3.1 Neck, Covers, Roofs, Walls, and Floor Slabs.
  - A. Cracks .012 inch or wider will be repaired.
  - B. Any spalled concrete .375 inch deep or greater or exposed rebar will be repaired.
- 3.2 Major defects or multiple patches can be cause for rejection.

**4.0 Actions from Delivery through the Warranty Period**

- 4.1 Cover
  - A. The supplier will replace the cover if cracks develop, regardless of size, that run from one edge to another edge or to the manhole opening, or appears to go through the concrete or through a ladder insert.
  - B. The supplier will replace the cover if a crack .062 inch wide or greater develops.
  - C. All other cracks and concrete spalls .375 inch deep or greater will be repaired by the supplier.

<sup>1/</sup> The supplier is the installing contractor.

Approved by: 	<b>Acceptance Criteria for the Installation of New Precast Vaults and Manholes</b>	<b>GI 031</b>
Effective Date: 10-26-2012	<b>What's Changed?</b> The acronym for the Miscellaneous Chapter of the UGS Manual has been changed from 'MS' to 'MC' for clarity.	Sheet 1 of 2 <b>UGS</b>

4.2 Roofs, Walls, and Floor Slabs

- A. Cracks .012 inch wide or greater will be repaired.
- B. Concrete spalls .375 inch deep or greater or exposed rebar will be repaired.
- C. SCE's Engineering Department will determine the remedial action to be taken by the supplier for cracks .125 inch wide or greater, or extensive smaller cracking.

4.3 Water intrusion due to structure quality problems, or improper installation, can be cause for rejection.

<b>GI 031</b>	<b>Acceptance Criteria for the Installation of New Precast Vaults and Manholes</b>	Approved by: 
Sheet 2 of 2	What's Changed?	Effective Date:
<b>UGS</b>		10-26-2012

**GI 035 Maximum Allowable Tolerances for Installed Precast Vaults and Manholes (Inside Joint Surfaces)**

**Scope GI 035.1 Maximum Allowable Tolerances for Installed Precast Vaults and Manholes (Inside Joint Surfaces)**

**Figure GI 035-1: Maximum Allowable Tolerances for Installed Precast Vaults and Manholes (Inside Joint Surfaces)**

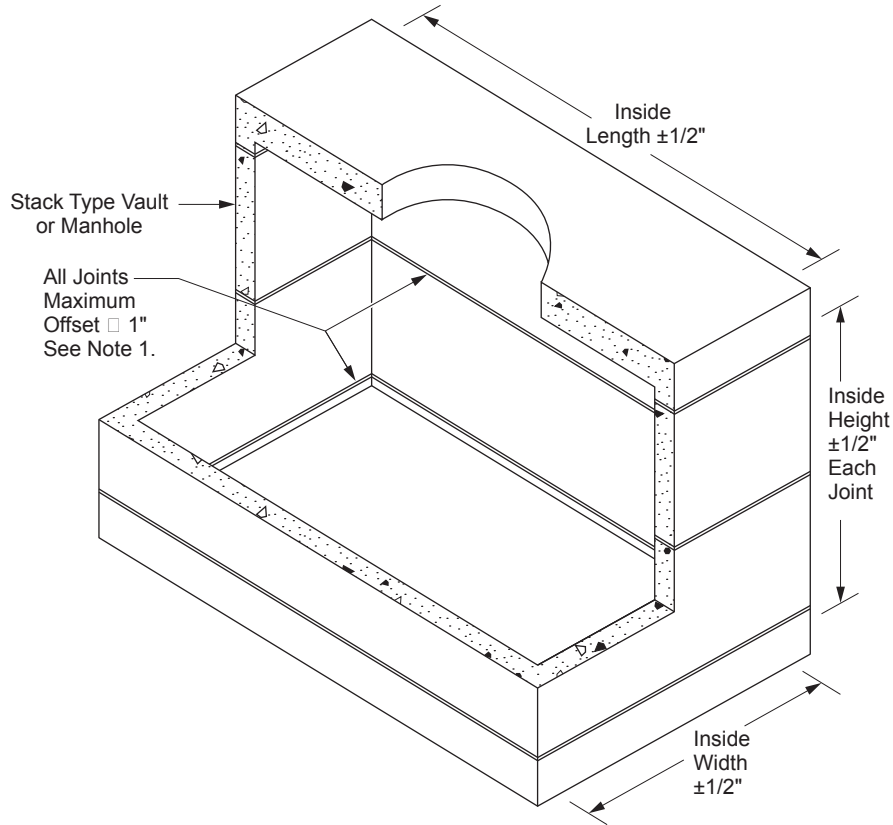

**Figure GI 035-1.1**

Approved by: 	<b>Maximum Allowable Tolerances for Installed Precast Vaults and Manholes (Inside Joint Surfaces)</b>	<b>GI 035</b>
Effective Date: 01-26-2007	<b>What's Changed?</b>	Sheet 1 of 2 <b>UGS</b>

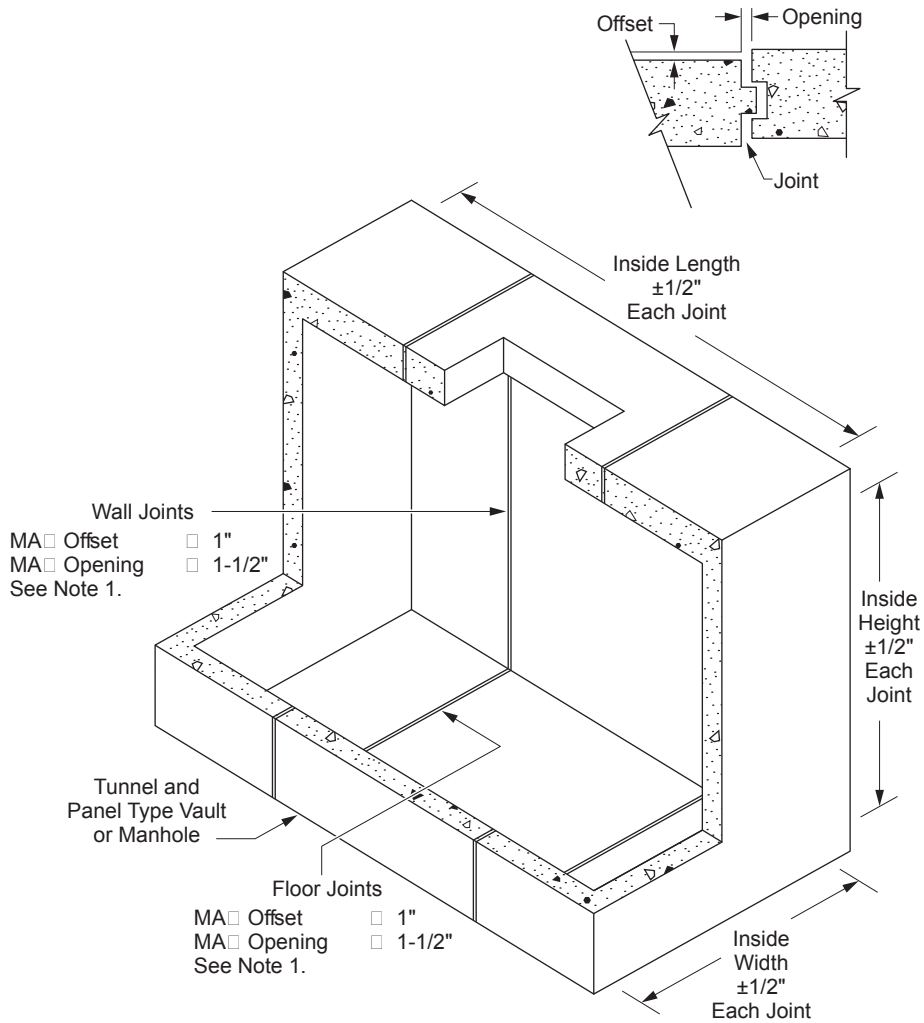

**Figure GI 035-1.2**

**Note(s):**

1. Openings between 1/2 inch and 1-1/2 inches and offsets between 1/2 inch and 1 inch will be feathered and grouted to an acceptable tolerance. Any values over these stated require the structure to be reset or replaced.
2. Due to manufacturing processes the top and bottom sections (stack type) and end sections (tunnel type) have an acceptable 1/2 inch per foot taper.
3. Corner tolerance on panel type structures is  $90^\circ \pm 1^\circ$ .
4. Bowing, in or out, in excess of 1/2 inch on any surface is not acceptable.
5. Tolerance on Unistrut or equal is  $\pm 1/8$  inch center to center.
6. Any grouting of joints will be done after backfill and compaction, and after the sealant has been allowed to completely compress.
7. All repair and replacement is to discretion of Company.

**GI 035**

**Maximum Allowable Tolerances for Installed Precast Vaults and Manholes (Inside Joint Surfaces)**

Approved by:

*PHH*

Sheet 2 of 2

What's Changed?

Effective Date:

**UGS**

01-26-2007

**GI 040 General Specifications for Pull Rope and Pull Tape**

**Scope GI 040.1 General Specifications for Pull Rope and Pull Tape**

**1.0 General Description**

These specifications cover the minimum requirements for pull ropes and pull tapes to be installed in the Southern California Edison Company's conduit systems. The pull rope and tape are generally provided and installed by company contractors, but may be installed by others. The rope or tape will be used by the Company to pull "bull" lines into the conduit system during the installation of electrical distribution cable.

**2.0 Material**

Pull ropes will be manufactured from a polypropylene material. The rope may be either braided or twisted. The pull rope may be single-strand or three-strand, but not two strand. Pull tapes will be manufactured from a woven polyester.

The rope and tape must maintain its strength and flexibility when exposed to water and corrosive conditions over extended periods of time.

**3.0 Size and Strength**

For conduit runs, pull ropes will have a minimum diameter of 3/8 inch and a minimum average tensile strength of 3,000 lb. A contrasting tracer color (one or more yarns in a single strand) may be included to identify the manufacturer. Use a minimum of 3/8 inch diameter pull rope regardless of conduit run lengths.

Pull tape shall be used for conduit sizes smaller than 4 inches, and will be approximately 3/4-inches wide with a 2,500 lb tensile breaking strength. The tape will include accurate sequential footage markings for measuring conduit run length. Pull rope is required in conduit sizes of 4", 5", and 6". Where the conduit is stubbed out to be picked up later, the pull tape must be secured outside the stub end of the conduit per [UGS CD 148](#), Note 5.

**4.0 Reel and Spool Marking**

All reels and spools will be clearly marked to show manufacturer and size in inches. The standard Edison pull tape reel size is 1,500 feet (SAP 10148986).

**5.0 Suppliers**

- Maydwell & Hartzell
- General Electric Supply
- The Shamrock Company (714) 547-4422

**6.0 Pull Tape Manufacturers**

- Neptco
- Redback

Approved by: 	<b>General Specifications for Pull Rope and Pull Tape</b>	<b>GI 040</b>
Effective Date: 10-23-2015	<b>What's Changed?</b> Minimum size for pull rope will be 3/8 inch diameter regardless of conduit run length.	Sheet 1 of 1 <b>UGS</b>

This page intentionally left blank.

**GI 045 General Specifications for Plowing Cable**

**Scope GI 045.1 General Specifications for Plowing Cable**

These general specifications are intended as a guide to minimum requirements for installing direct buried cable by the plow method. All specific requirements shown on working drawings, governmental permits, and all applicable city, county, and state ordinances will also be complied with.

Reference to Company in this specification will mean the Southern California Edison Company; reference to contractor will mean the organization performing the specified work.

**1.0 Contractor Responsibilities**

- 1.1 The contractor will furnish all equipment, labor, tools, and supervision necessary to place the cable.
- 1.2 Any damage to substructures, equipment, or plant which is caused by the contractor will be repaired by and at contractor's expense and to the satisfaction of the Company.
- 1.3 Any settling or washout of the trench area due to improper cable installation within one year of acceptance of work will be repaired by and at the contractor's expense and to the satisfaction of the Company.
- 1.4 The contractor will transport Company furnished material as referenced on the working drawing from the designated storage area to the job site. The contractor will be responsible for the safe keeping of all cable, reels, and all other material after leaving the storage area. Following completion of work, all reels and excess material not installed are to be returned to the storage area.

**2.0 Construction Requirements**

- 2.1 Installation of the cable will generally be from the higher elevation to the lower elevation when terrain is mountainous.
- 2.2 Cable will be installed to 36 inches minimum depth. Minimum cover at water crossings (specified on the working drawings) will be 60 inches. At those locations, sand bagging to a height of two feet above grade will extend the full width of the watercrossing.
- 2.3 Cable route will be pre-ripped to minimum cable depth and in the same direction as the cable is to be installed.
- 2.4 Cable route that cannot be ripped will be trenched prior to plowing to permit continuous cable installation.
- 2.5 All cable will be installed in the same trench with the initial plow pass.
- 2.6 Water deflection berms (dikes) consisting of sand bags will be installed at 60° to the trench on all slopes at intervals not to exceed ten feet vertical difference in elevation or as directed by the Company. Berms or dikes will extend beyond the trench area sufficiently to prevent water flowing back into the trench. Trench plugs, consisting of stabilized earth (one part cement to ten parts earth) in burlap sacks, will be installed at locations specified on the working drawings. Plugs will extend the full depth of the cable trench.

Approved by: 	<b>General Specifications for Plowing Cable</b>	<b>GI 045</b>
Effective Date: 01-26-2007	<b>What's Changed?</b>	Sheet 1 of 3 <b>UGS</b>

When applicable, water deflection berms will also meet or exceed all local ordinances or other requirements of local governing agencies.

- 2.7 Marker posts are to be installed 30 inches above grade at angle points in route, at both sides of each road crossing, and otherwise at intervals not to exceed 500 feet. Posts and signs will be furnished by the Company.
- 2.8 A trench will be provided at splicing points to permit make up of splices. Unless specified otherwise, an 8" x 36" x 36" deep concrete splice box will be installed at each splice point. Splice boxes will be buried 6 to 12 inches with a 3-inch diameter, 5-foot length HDG pipe marker placed 5 feet to the side and 30 inches above grade at each box. Each marker will be identified on the side facing the box with the words "Splice Box, 5 Feet" stamped into the pipe.
- 2.9 Excavations, not to exceed five per mile, may be required by the Company to determine depth and bedding of the cable.
- 2.10 Upon completion of plowing, excavation, and backfill, the ground surface will be restored to a condition as least as good as it was previous to start of work. All applicable local compaction requirements will be met. If required by permit, the route will be replanted or seeded.

**3.0 Plow Requirements**

- 3.1 Plows will have sufficient drawbar pull to install cables in one pass (after ripping). Raising and lowering the feed shoe to by-pass rock or other obstacles will not be permitted.
- 3.2 Plow will accommodate a minimum of two reels with maximum diameters of 78 inches, maximum widths of 54 inches and an approximate weight of 3,000 lb each. A third reel, when required, may be towed on a separate reel dolly.
- 3.3 Cable will not be permitted to pass over stationary guides, rollers, or sheaves which will permit a bend radius of less than 15 times the cable diameter.
- 3.4 Cable will be fed into the ground in a manner to prevent stress upon the cable.
- 3.5 Cable reels will have a tension governing device to pay out cable evenly (without tension). A reel tender operator may be substituted.
- 3.6 Cable will be protected from damage at all times. Guards will be provided over engine exhausts and the feed shoe fabricated such that the cable will not bear or "ride" upon rock or other obstructions.

**4.0 Company Responsibilities**

- 4.1 The Company will furnish all necessary permits.
- 4.2 The Company will furnish materials as specified on working drawings at the designated storage areas.
- 4.3 The Company will perform all cable splicing and testing.

<b>GI 045</b>	<b>General Specifications for Plowing Cable</b>	Approved by: 
Sheet 2 of 3	What's Changed?	Effective Date: 01-26-2007
<b>UGS</b>		



- 4.4 The Company will inspect work in progress. The contractor is responsible for informing the Company 24 hours in advance of any cable installation. Final acceptance will be based on electrical tests of cable performed by the Company.

Approved by: 	<b>General Specifications for Plowing Cable</b>	<b>GI 045</b>
Effective Date: 01-26-2007	<b>What's Changed?</b>	Sheet 3 of 3 <b>UGS</b>

This page intentionally left blank.

**GI 050 Specification for Abandoning Substructures**

**Scope GI 050.1 Specification for Abandoning Substructures**

**1.0 Substructures**

- 1.1 All portions of the substructure within four feet of grade will be removed, unless otherwise specified.
- 1.2 Sufficient holes will be knocked through the floor to allow satisfactory drainage of the fill material.
- 1.3 The substructure will be filled completely with sand or other material acceptable to the inspector.
- 1.4 Vents will be cut off a minimum of one foot below ground level and filled. When filling is not practical, the vent will be capped.



**NOTE**

Some abandoned materials may be reusable. Consult the Underground Construction Manager for status of covers, grates, and so on. Any plant to be abandoned will be called out on the working drawing.

Approved by: 	<b>Specification for Abandoning Substructures</b>	<b>GI 050</b>
Effective Date: 01-26-2007	<b>What's Changed?</b>	Sheet 1 of 1 <b>UGS</b>

This page intentionally left blank.